

ENP-CAN Module

Quick Start Guide

 <p>For indoor use only</p>	 <p>For humid environments, additional IP68 protection is needed</p>	 <p>Regularly check all parts for damage</p>
--	---	---

1 Connect the Module to the Endpoint Device and External Power Supply

 All information about Enapter devices can be found at handbook.enapter.com.
Contact support at support@enapter.com.

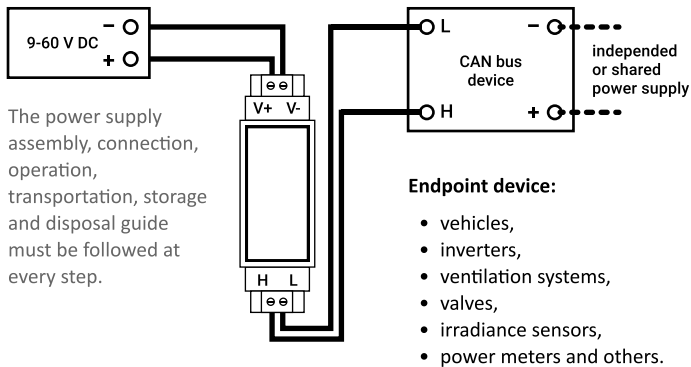



2 Screw Wi-Fi Antenna into the Port

Module sends the collected data to the Enapter Gateway and Cloud via secure wireless connection:

- Wi-Fi 2.4 GHz
- Bluetooth 4.0 LE

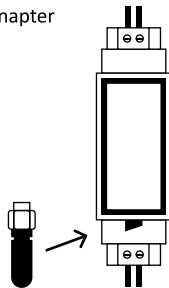
 Make sure the antenna is connected to the port.



 **Alternating current voltage of 110-220 V is potentially lethal!**

 **All assembly and installation works should be only performed with a disconnected power supply!**

3 Follow the Enapter App Instructions to Connect the Device to Enapter Cloud



To download the app, scan the QR-code with your Android or Apple mobile phone or visit app.enapter.com

- Open the Enapter app and create an **account**.
- Follow the steps to create a **site**.
- Press the **Add device** button.

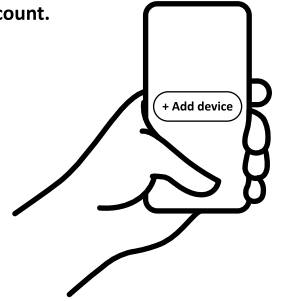

4 Scan QR-code on the Side of Module With Enapter App

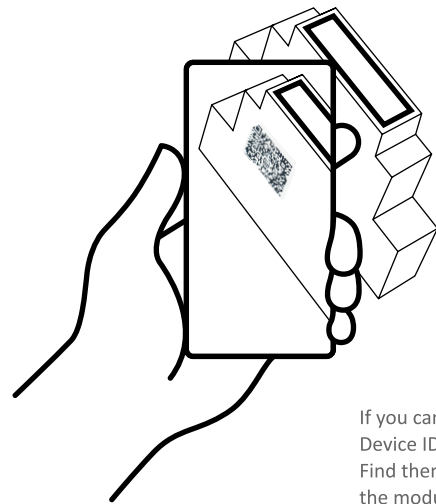

If you can't scan, enter Device ID and PIN manually. Find them on the side of the module.

5 Monitor Device Activity

During normal operation, the LEDs indicate the status of the module. Monitor device activity in **Enapter App** or **Enapter Cloud**.

